

Accuphase

STEREO PREAMPLIFIER

C-222

- Built-in multi-function head amp
- All stages push-pull, DC servo direct coupled
- Multiple power supply



All-stage push-pull circuitry. DC servo direct coupled through Head amp with selectable input impedance and gain for opti

In 1977, we introduced the Accuphase C-220, a preamplifier designed exclusively for disc sources. The Accuphase C-220 was widely acclaimed by disc fans everywhere for its superb performance. However, because of the increasing difficulty of procuring principal devices for its assembly, we were forced to suspend production in 1980.

The new Accuphase C-222 preamplifier is also designed primarily for disc reproduction. However, it has, with its LINE INPUT and TAPE PLAY/REC terminals, the added versatility of accommodating other sources as well. A Loudness Compensator and a Filter Network are also provided to eliminate infrasonic noise.

The C-222 is a high quality Direct Coupled (DC) preamplifier. Its basic circuitry utilizes an all-stage push-pull arrangement with cascode amplification. The use of coupling capacitors has been completely obviated in the C-222, from the MC (Moving Coil cartridge) input stage to the output stage. An effective DC Servo Control system makes this possible by covering all of the unit amplifiers.

The C-222 has a greatly strengthened multiple power supply system that provides each unit amplifier with its own voltage regulated power supply. This ensures the ample supply of low impedance energy all the way into the ultra high frequency range, and minimizes interference between unit amplifiers.

The preservation of sound purity and achievement of the highest quality sound reproduction were the main objectives in creating the C-222 preamplifier. These considerations governed not only the choice of sophisticated circuitry, but also were our incentive for developing special devices to preserve sound purity. The design of the circuit board patterns creates the shortest signal path layouts for devices and circuit components and in this way contributes to the fulfillment of the above objectives.

The C-222 is equipped with an Input Load Impedance Selector Switch and a Head Amp Gain Switch that accommodate and improve matching conditions with MC cartridges having differing impedances and/or wide variations of output voltage levels.

The quality of this preamplifier's Line Input has been raised to the highest degree possible, making it a truly "new era" preamplifier. It is also ideal for preamplifying CD (Compact Disc) program sources.

The Front Panel presents a neat, easy-to-use layout which includes only the Volume, Input Selector and Attenuator Function Controls. Less frequently used function controls are all placed in the lower sub-panel.

The C-222 Preamplifier, when used with one of the following Accuphase power amplifiers: the P-266 (130 W/ch); the P-300X (150 W/ch); or the P-400 (200 W/ch), makes an ideal sound reproduction combination.

1 PUSH-PULL CIRCUITRY THROUGHOUT WITH DIFFERENTIAL AMPLIFIER INPUT, CASCODE PRE-DRIVE AND DARLINGTON PAIR OUTPUT STAGES

An amplifier's basic characteristics are largely determined by its circuit configuration. In this sense, its circuit makeup is the most important factor.

Figure 1 shows the circuit diagram of the C-222's equalizer and high-level amplifier sections in progressive stages, each of which features push-pull circuitry throughout. At the input stage is a differential amplifier with FET buffer. The cascode Pre-Drive stage comprises transistors Q9-Q12 and the Darlington Pair Output transistors Q13-Q16.

High frequency range amplification is delegated mainly to the two Cascode Pre-Drive Amp sections made up of two transistors each (Q9/Q11 and Q10/Q12). This cascode stage possesses superior high frequency characteristics and ensures stable operation with very low distortion.

The Darlington output also is made up of two pairs of transistors: Q13/Q15 and Q14/Q16.

Low distortion and stable amplification are assured because the input impedance of this stage can be multiplied by the h_{FE} (Static Forward Current Transfer Ratio) of Q13 and Q14. These circuit considerations, reinforced by a push-pull makeup throughout, have enabled us to achieve the highest signal purity and sound quality with superior basic amplification characteristics before NFB (Negative Feedback) application.

2 HEAD AMPLIFIER WITH WIDE DYNAMIC RANGE AND HIGH SIGNAL-TO-NOISE RATIO

An exclusive amplifier for MC cartridges with flat characteristics is placed before the equalizer amplifier to solve fundamentally the problems caused by the low level signals involved. Figure 2 shows the head amplifier circuit.

The output of MC cartridges is fed directly to the input circuit without passing through the FET buffer. Because the head amplifier handles very low level signals, noise prevention re-

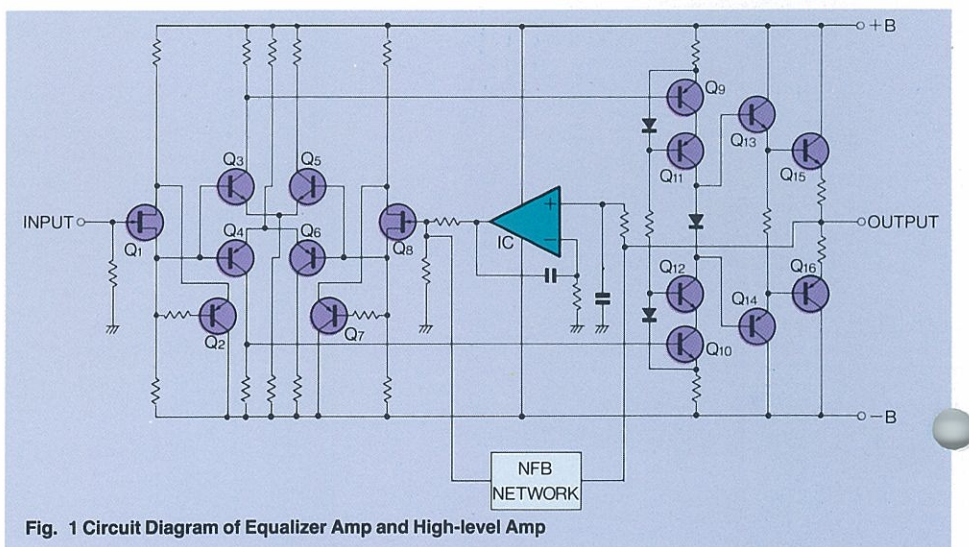

Fig. 1 Circuit Diagram of Equalizer Amp and High-level Amp

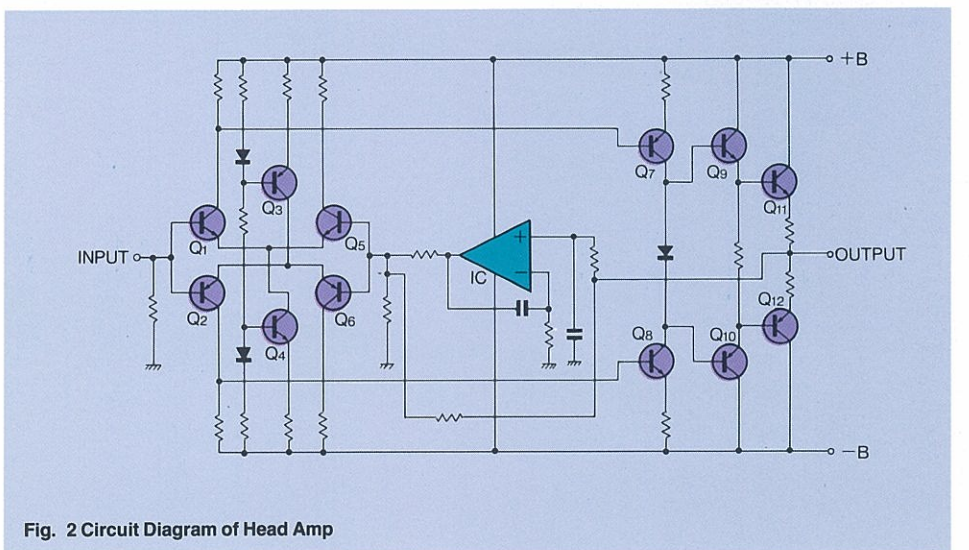
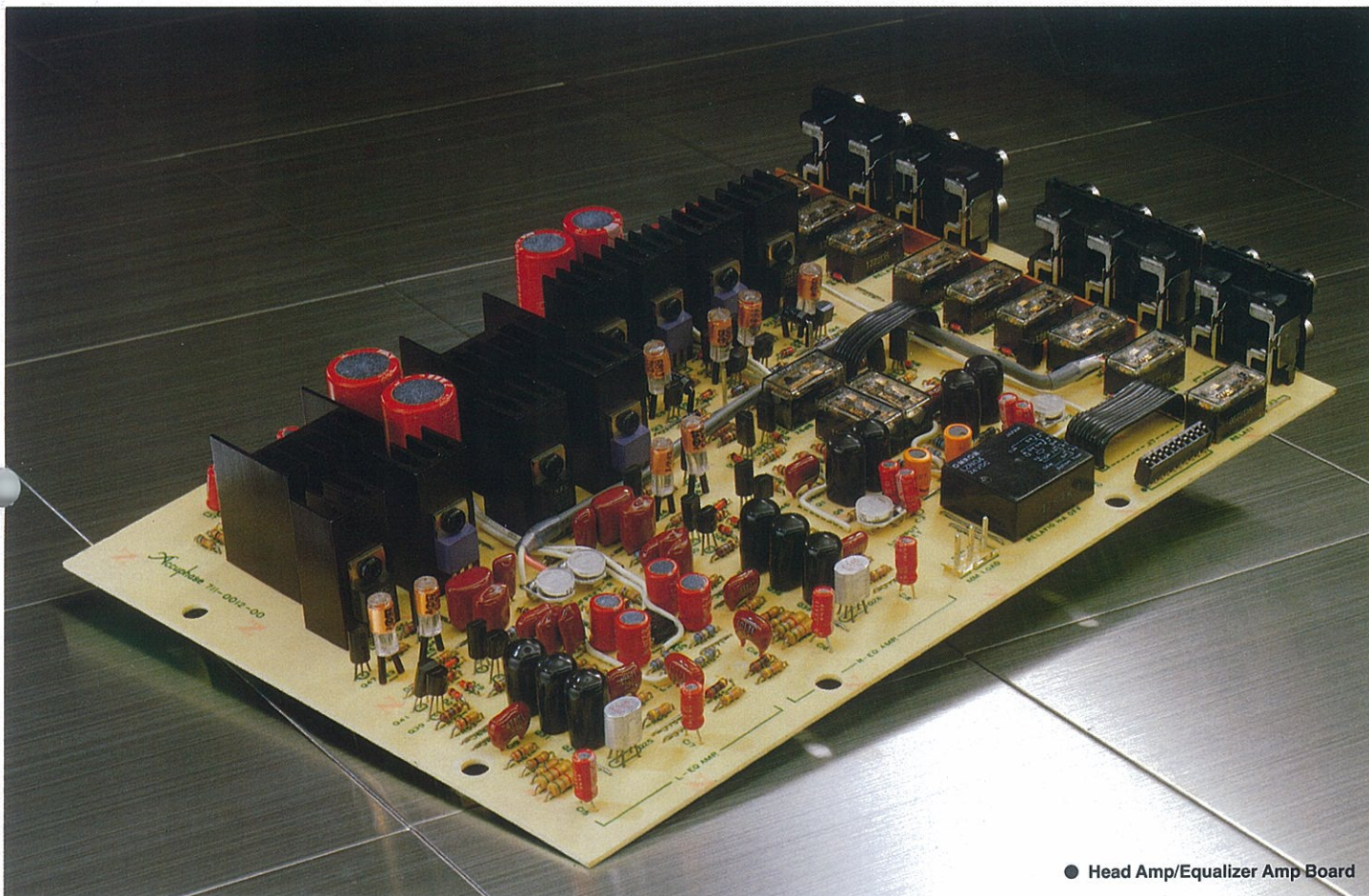

Fig. 2 Circuit Diagram of Head Amp

ut. "Multiple power supply".
 im matching with MC cartridges.



● Head Amp/Equalizer Amp Board

ceived top priority. Low noise devices were carefully selected, and low impedance of the NFB loop was secured. As even the noise created in the Voltage Regulator circuit of the Power Supply can adversely affect the S/N ratio of a head amplifier, efforts were expended to select low noise devices for this section as well, and special attention was paid to the layout of signal paths to keep noise pickup to the minimum theoretically possible.

The C-222 has a wide dynamic input level range which permits maximum input voltages up to 150 mV (head amp gain 26 dB). It can therefore accommodate any MC cartridge without danger of saturation.

3 STRAIGHT DC AMPLIFICATION FROM MC INPUT TO OUTPUT THANKS TO DC SERVO SYSTEM COVERING ALL UNIT AMPLIFIERS

The IC shown in Figures 1 and 2 constitutes the DC Servo Control circuit. This IC eliminates DC drift by feeding back to the input any DC current appearing at its output. The C-222 has a maximum total gain of 92 dB. Yet, all of its signal paths, from the MC cartridge input to the final output, are directly coupled one stage to the next in a straight DC operation. This is made possible by good circuit design and the use of an effective DC Servo system which eliminates

DC drift completely. This feature also accounts for the high quality sound of the C-222 that carries no trace of coloration.

4 EACH UNIT AMP HAS ITS OWN POWER SUPPLY

The 92 dB total gain of this preamplifier means a voltage gain of some 40,000 times, a truly amazing figure. If only a single common power supply were to be used for all of the unit amps, the large amplitude of the output voltage would cause considerable power supply fluctuation and result in instability of the input stage, distortion and oscillation. Ideally, therefore, each unit amplifier should have a completely independent power source for optimum stable operation.

The C-222 resolves this problem by employing a multi-power supply system that strengthens and regulates the various power sources. Each unit amp is provided with its own constant voltage supply source, located close by. In effect, this means that each unit amp has its own completely independent power supply and this in turn accounts for the great stability of the C-222 preamplifier.

5 LOGIC CONTROLLED RELAYS USED TO SHORTEN SIGNAL PATHS

The long signal path leads necessitated by the switching connections for program selection, tape monitoring, etc., are liable to induce unstable factors that can cause deterioration of

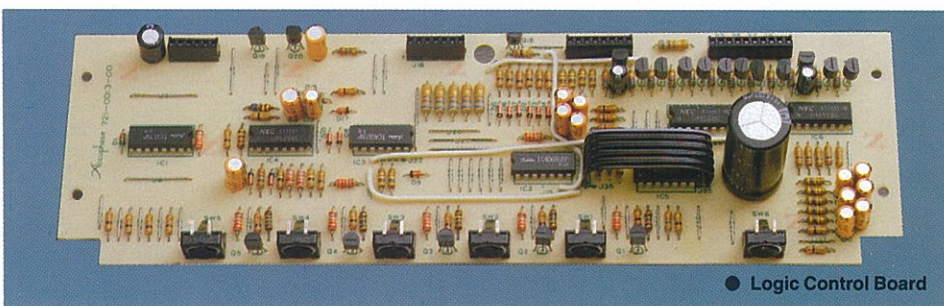

● Logic Control Board

high frequency signal quality. To prevent this, the C-222 employs logic circuit controlled relays strategically located between the input terminals and the circuit boards to create the straightest and shortest signal input leads possible.

In such a system, the quality of the relay is crucial. The C-222 employs reliable crossbar-twin type relays specially developed for audio use.

These relays, with their contact points of thinly gold-plated silver palladium alloy, assure long life, and sure contact action. Moreover, these relays are sealed in casings to prevent corrosion.

6 HEAD AMP'S IMPEDANCE AND GAIN SELECTORS ENSURE BEST INPUT MATCHING WITH MC CARTRIDGES

The C-222 was specially designed to obtain ideal reproduction from MC cartridges that have wide variations of impedances and output levels. For example, the output impedances of MC cartridges vary from 2 ohms to almost 50 ohms, a difference of some 20 to 30 times. Output voltage levels, too, can vary from 0.01 mV to 0.5 mV, a difference of 50 times (34 dB). Although matching MC cartridges to the head amplifier is not as critical as transformer coupling, for best performance, low output impedance cartridges should be coupled to low input impedances.

To accommodate the wide variety of MC cartridges and preserve fine control of sound quality, the C-222 provides the following choice of input impedances: 10 ohms, 30 ohms or 100 ohms.

This allows you to couple MC cartridges in the 3-ohm impedance range to a load of 10 ohms or 30 ohms, and cartridges with greater than 10-ohm impedance to a load of either 30 ohms or 100 ohms for closer matching.

Also to accommodate MC cartridges with very low output levels, a Gain Selector switch in the C-222 raises the gain to 32 dB rather than the normally operated head amp gain of 26 dB.

7 LOAD CAPACITANCE SELECTOR PERMITS ADJUSTMENTS OF MM CARTRIDGE SOUND CHARACTERISTICS

The factors, other than the normal 47-k ohm impedance of the amplifier input, that determine the load of MM (Moving-Magnet) cartridges are the stray capacitances created by the tone arm, the shielded lead-in cords and amp input connectors. Generally, it can be said that the lower the stray capacitance, the flatter the response characteristics of the amplifier. However, use of higher capacitance is often recommended by some manufacturers of cartridges. To cope with such conditions, a Load Capacitance Selector is provided.

This permits additional capacitance selection of 100 pF, 200 pF and 400 pF and allows the user to choose the response characteristics to suit his personal preference.

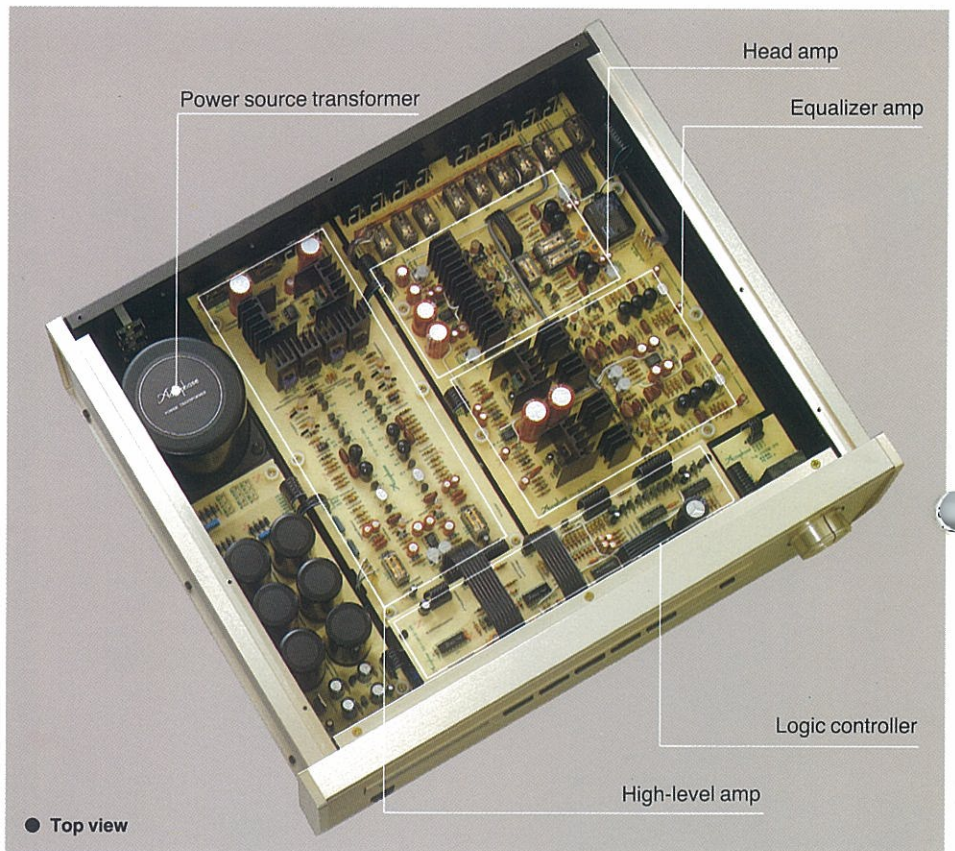

8 COMPLETE TAPE RECORDING FUNCTIONS

Although priority was given to disc preamplification, the recording and reproduction of tapes were not overlooked. The C-222 provides connections to two tape recorders for recording, playback and monitoring.

9 -20 dB ATTENUATOR PROVIDED

An attenuation control is convenient when beginning record play, searching for tape positions, or temporarily muting the volume level when answering the phone. A -20 dB Attenuator is provided for this purpose and is conveniently located next to the VOLUME control.

10 EFFECTIVE FILTER (17/Hz/-12dB/oct) ELIMINATES HARMFUL INFRASONIC NOISE

An effective -12dB/oct Filter is provided to eliminate infrasonic noise without affecting the audio frequency range. This is especially effective to eliminate the effects of harmful, unnecessary vibrations in the 2 Hz range such as those created by stylus vibrational contact with disc grooves.

11 LOUDNESS COMPENSATOR ENSURES ACOUSTIC BALANCE AT LOW LISTENING LEVELS

The C-222 does not have a tone control. However, it features automatic loudness compensation instead, which is determined by the setting of its volume control.

At low listening levels, this feature boosts the volume of lower frequency range sounds to compensate for the inability of human hearing to perceive the true volume of such sounds. This helps maintain the audible sound balance when listening at low volume levels.

The C-222 offers a choice of two loudness compensation curves by switch selection.

12 CONVENIENT HEADPHONE JACK PROVIDED

A convenient headphone jack is provided for monitoring or late-hour listening. This jack can be used for a wide variety of headphones ranging in impedance from 4 to 100 ohms.

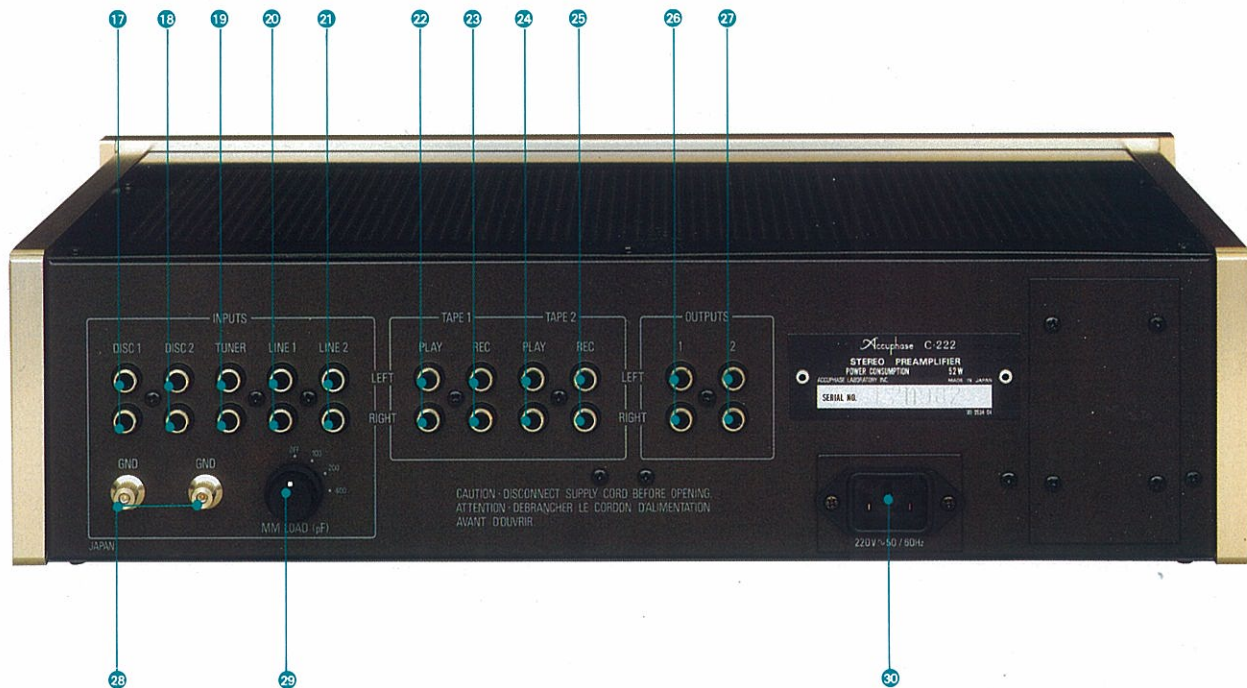
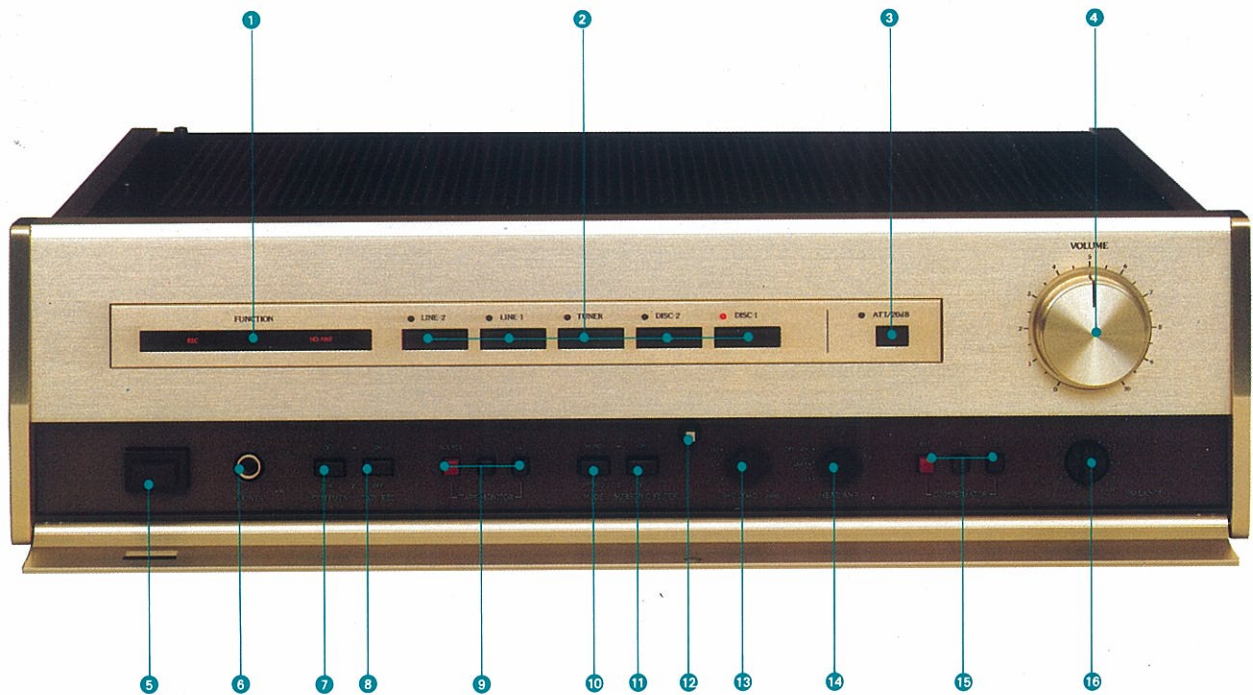

- ① Subpanel function operation indicator lamps
- ② Input selector LINE 2 LINE 1 TUNER DISC 2 DISC 1
- ③ ATTenuator OFF/−20 dB
- ④ VOLUME controller
- ⑤ POWER switch
- ⑥ Stereo headPHONE jack
- ⑦ OUTPUT switch ON OFF
- ⑧ TAPE REC output ON OFF switch
- ⑨ TAPE MONITOR switch SOURCE 1 2
- ⑩ MODE selector switch ON OFF

- ⑪ SUBSONIC FILTER switch ON OFF
- ⑫ Subpanel magnetic catch
- ⑬ Input LOAD impedance selector switch
- ⑭ HEAD AMP gain switch
- ⑮ COMPENSATOR switch OFF 1 2
- ⑯ BALANCE control
- ⑰ DISC 1 input jacks
- ⑱ DISC 2 input jacks
- ⑲ TUNER input jacks
- ⑳ LINE 1 input jacks
- ㉑ LINE 2 input jacks

- ㉒ TAPE 1 input jacks
- ㉓ TAPE 1 recording output jacks
- ㉔ TAPE 2 input jacks
- ㉕ TAPE 2 recording output jacks
- ㉖ Output jacks
- ㉗ Output jacks
- ㉘ Ground terminal
- ㉙ MM cartridge LOAD capacitance selector switch OFF 100 pF 200 pF 400 pF
- ㉚ AC power cord receptacle

GUARANTY SPECIFICATIONS

● PERFORMANCE GUARANTY:

All Accuphase product specifications are guaranteed as stated.

● FREQUENCY RESPONSE:

TUNER/LINE/

TAPE PLAY INPUT: 1 Hz to 500,000 Hz: +0, -3.0 dB

20 Hz to 20,000 Hz: +0, -0.2 dB

DISC INPUT: 20 Hz to 20,000 Hz: ±0.2 dB

● TOTAL HARMONIC DISTORTION (IHF Standard):

Will not exceed 0.005% at rated output level, 20 Hz to 20,000 Hz

● INPUT SENSITIVITY AND IMPEDANCE:

Input Terminal	Sensitivity		Impedance (ohm)
	Rated Output	IHF Standard (0.5V Output)	
DISC (Head Amp: OFF/MM)	2.0 mV	0.5 mV	47 k
DISC (Head Amp: +26 dB)	0.1 mV	0.025 mV	10, 30, 100
DISC (Head Amp: +32 dB)	0.05 mV	0.0125 mV	10, 30, 100
TUNER/LINE/TAPE PLAY	126 mV	31.5 mV	20 k

● OUTPUT LEVEL AND IMPEDANCE:

OUTPUTS: 2.0 V, 1.0 ohm

TAPE REC: 126 mV, 200 ohms (Input: DISC)

● A-WEIGHTED SIGNAL-TO-NOISE RATIO:

Input Terminal	Rated Input	IHF Standard
DISC (Head Amp: OFF/MM)	85 dB	85 dB
DISC (Head Amp: +26 dB)	72 dB	78 dB
DISC (Head Amp: +32 dB)	66 dB	78 dB
TUNER/LINE/TAPE PLAY	110 dB	90 dB

● MAXIMUM OUTPUT LEVEL (at 0.005% distortion, 20 Hz to 20,000 Hz):

OUTPUTS: 8.0 V

TAPE REC: 19.0 V (Input: DISC)

● HEADPHONE JACK:

For listening with low impedance (4 to 100 ohms) dynamic stereo headphones

● MAXIMUM INPUT FOR DISC INPUT (at 0.005% distortion, 1 kHz):

HEAD AMP OFF: 300 mV

HEAD AMP +26 dB: 15 mV

HEAD AMP +32 dB: 7.5 mV

● MINIMUM LOAD IMPEDANCE:

OUTPUTS: 1 kohms

TAPE REC: 10 kohms

● VOLTAGE AMPLIFICATION IN DECIBELS:

TUNER/LINE/TAPE PLAY Input to OUTPUTS: 24 dB

TUNER/LINE/TAPE PLAY Input to TAPE REC Output:

0 dB

DISC (Head Amp: OFF/MM) Input to OUTPUTS: 60 dB

DISC (Head Amp: OFF/MM) Input to TAPE REC Output:

36 dB

HEAD AMP gain: Selectable for +26 dB and +32 dB

● LOUDNESS COMPENSATOR (volume attenuation at -30 dB):

1: +3 dB at 100 Hz

2: +8 dB at 100 Hz, +6 dB at 20 kHz

● SUBSONIC FILTER: 17 Hz cutoff, -12dB/oct.

● ATTENUATOR: -20 dB

● SEMICONDUCTOR COMPONENT:

109 Tr's, 9 FETs, 13 ICs and 94 Di's

● POWER REQUIREMENT:

Voltage selection by rewiring for 100V, 117V, 220V and

240V, 50/60 Hz operation

Power Consumption: 50 watts

● DIMENSIONS:

445 mm (17-1/2 inches) width

128 mm (5-1/16 inches) max. height

373 mm (14-11/16 inches) depth

● WEIGHT: 9.7 kg (21.3 lbs) net, 14.1 kg (31.0 lbs) in shipping carton

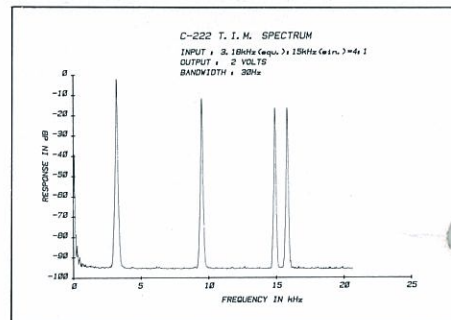
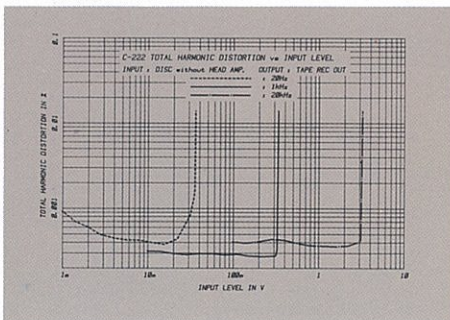
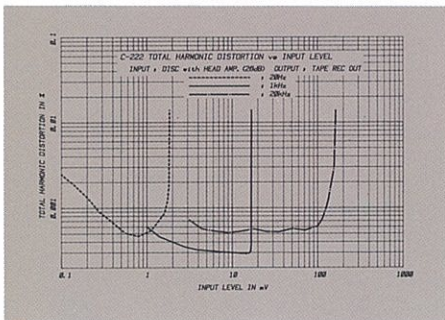
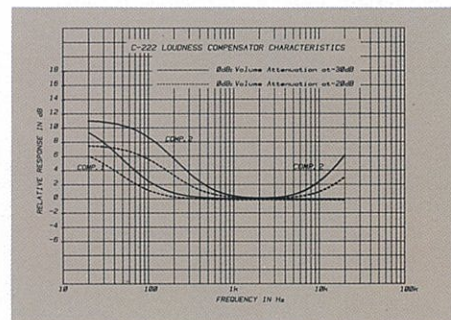
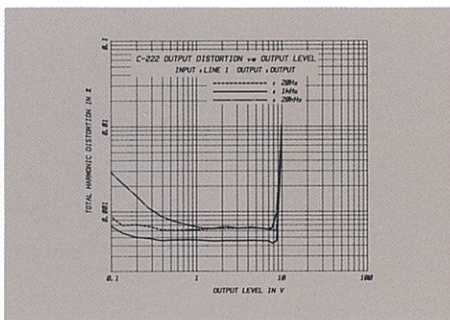
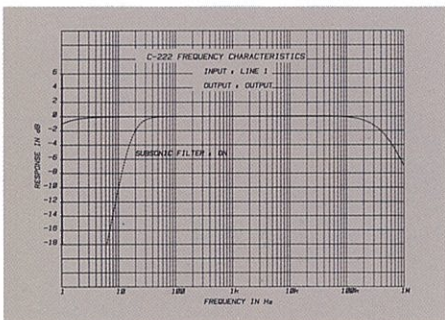

The above data shows the spectrum characteristics of transient intermodulation distortion for the C-222 when two mixed input signals, a 3.18 kHz square wave and a 15 kHz sine wave, are used. Since harmonics of square waves appear almost infinitely at odd-number multiples, for example in this case at 9.54 kHz (3rd harmonic) and 15.9 kHz (5th harmonic), they can create, together with the 15 kHz input sine wave, intermodulated spectrums at frequencies where input signals are absent. For example, if the third harmonic of the 3.18 kHz square wave (9.54 kHz) and the 15 kHz input signal intermodulate, a spectrum can appear at the difference of their frequencies, or 5.46 kHz (15-9.54=5.46 kHz). However, the above data shows no spectrum above -93 dB at that frequency. This confirms that TIM distortion is less than 0.0022%.

